

A

A

B

B

C

C

D

D

E

E

F

F

PE N L

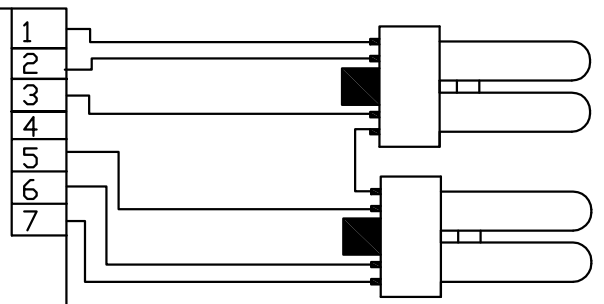
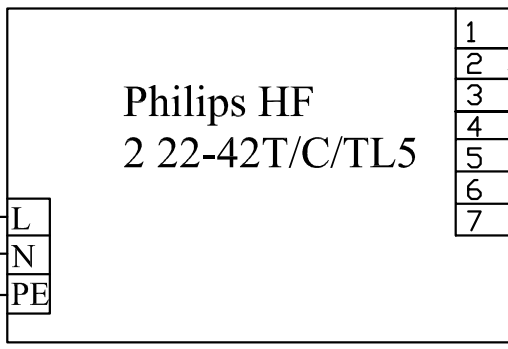
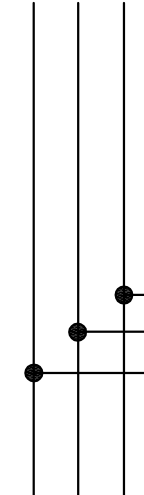

PE N L

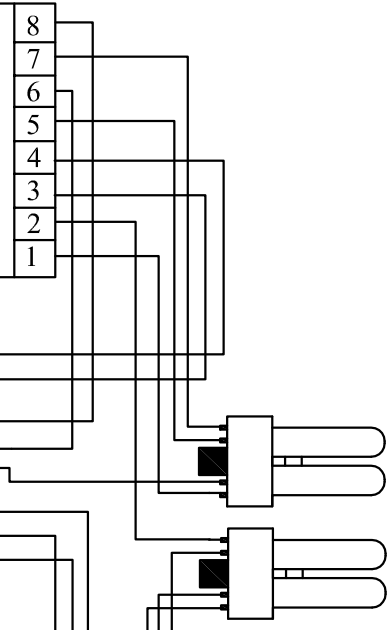
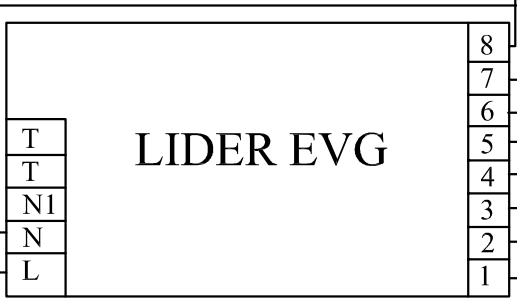
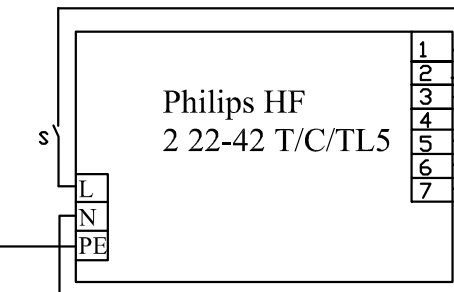
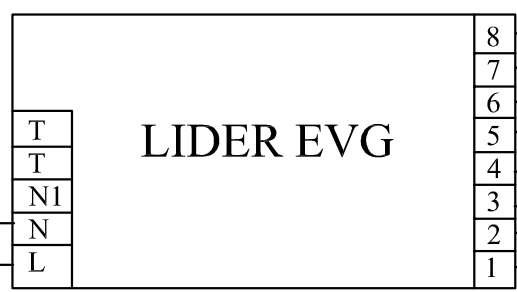
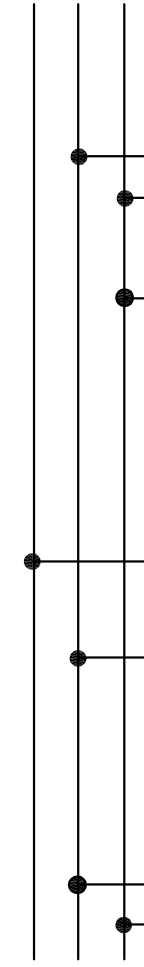

Poz.	Ilość	Tytuł/nazwa, materiał, wymiary itp.	Numer
Projektował Awex	Sprawdził Awex	Zatwierdził – data Awex–2009/11/20	Nazwa pliku hf 2–22–42
		Data 2009/11/20	Skala 1:1
P.P.H.U. AWEX		Philips HF 2 22–42	
		NIE TESTOWANY	Edycja Arkusz 1/1

1

4