

A

A

B

B

C

C

D

D

E

E

F

F

PE N L

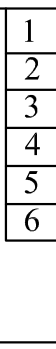
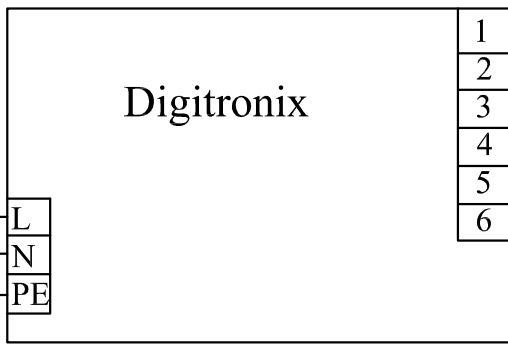
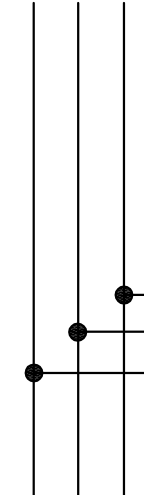

PE N L

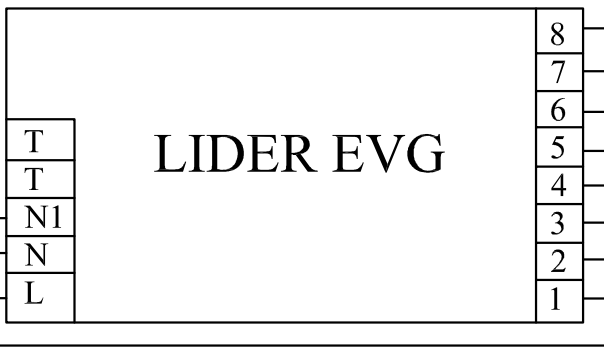
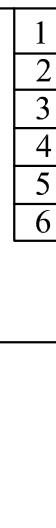
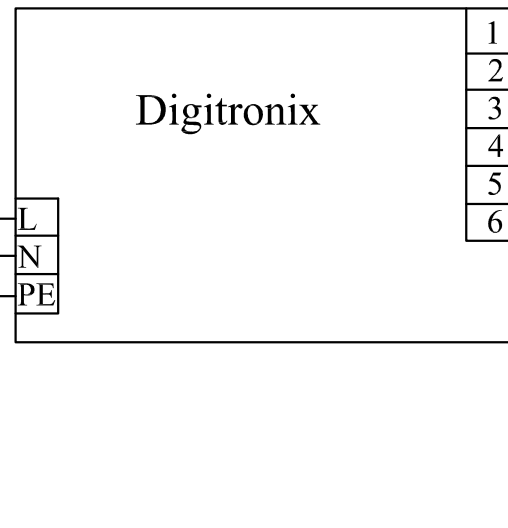
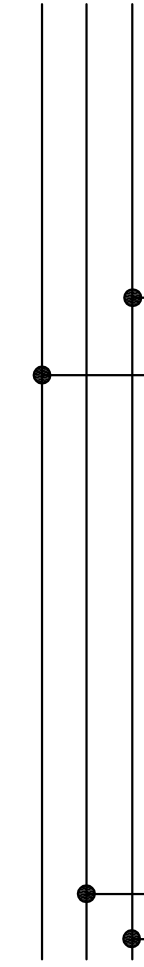

Poz.	Ilość	Tytuł/nazwa, materiał, wymiary itp.	Numer		
Projektował Awex	Sprawił Awex	Zatwierdził – data Awex–2009/07/13	Nazwa pliku	Data 2009/07/13	Skala 1:1
P.P.H.U. AWEX			Digitronix 2x		
				Edycja 1/1	Arkusz 1/1

1

4